

# CYLINDER ACCESSORIES

## CYLINDER LIFTING HANDLES

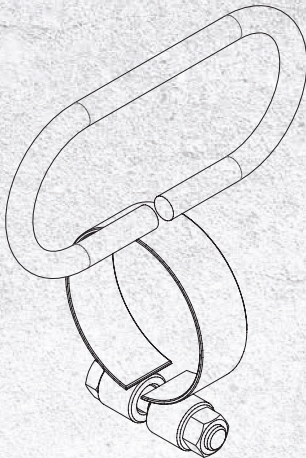

- Designed for ease of carrying
- Provides better control for positioning cylinder

Model Number	For Cylinders
LH25T34	H2504 through H2514
LH30T40	H3008, HD3008, HD3014, HC2002T, HC2006T
LH30T45	HC3002T, HC3006T, HD3007, HDC3010
LH55T49	HLN5504 through HLN5512

## CLEVIS AND TANGS

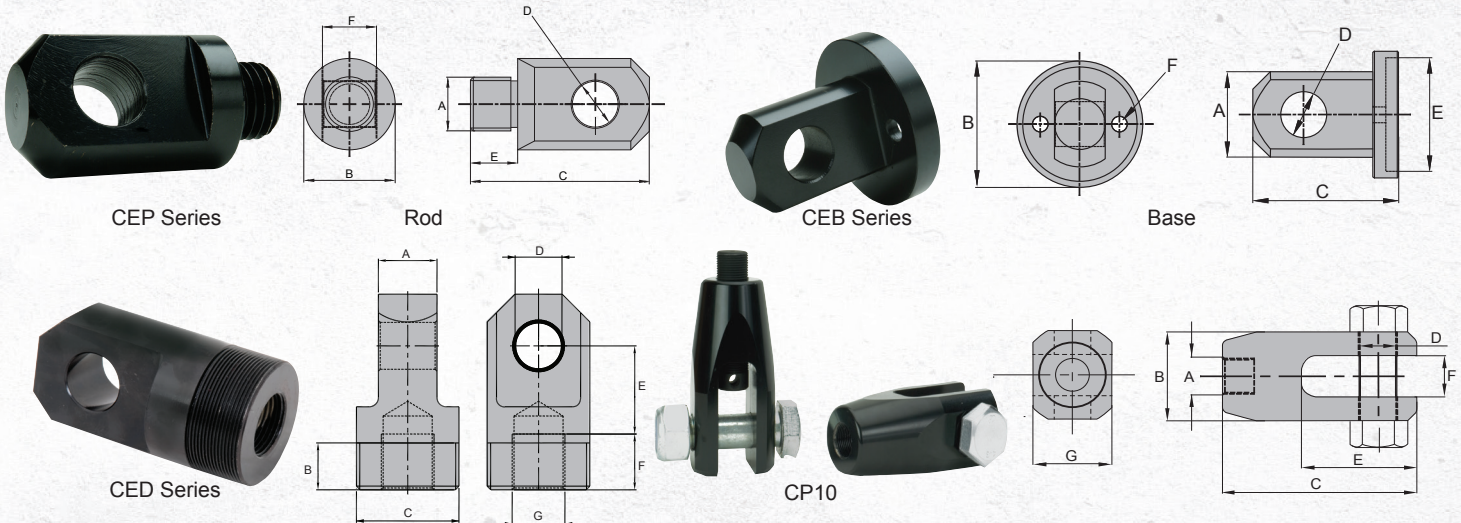

Application	For use with Cylinder Capacity (tons)	Model Number	Dimensions (in)						
			A	B	C	D	E	F	G
Rod	5	CEP05	3/4"-16UNF	1.13	2.25	0.63	0.62	0.56	-
	10	CEP10	1"-8UNC	1.69	3.31	0.88	0.75	1.00	-
	15	CEP15	1"-8UNC	1.69	3.31	0.88	0.75	1.00	-
	25	CEP25	1 1/2"-16	2.25	3.81	1.25	0.87	1.50	-
Base	5	CEB05	1.52	1.75	2.13	0.63	0.26	1.13	-
	10	CEB10	2.28	2.50	2.87	0.88	1.69	0.32	-
	15	CEB15	2.77	3.00	2.87	0.88	1.69	0.38	-
	25	CEB25	3.40	3.75	3.37	1.25	2.25	0.56	-
Rod & Base	9	CED09	1	1	1-11/16"-18	0.75	1.31	0.94	3/4"-16
	16	CED16	1.25	1	2-3/16"-16	1	1.88	1.19	1 1/8" 12
	HP1006 only	CP10*	M30x2	2.95	6.30	1.18	3.74	1.38	2.56

\* 2-pc set with an adapter



## BASES

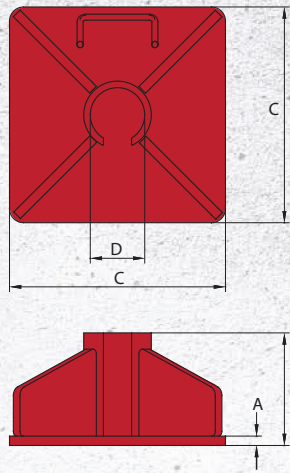

For use with Cylinder Capacity (tons)	Model Number	Dimensions (in)			
		A	B	C	D
5	CB05	0.32	4.65	7.87	1.54
10	CB10	0.39	4.72	9.06	2.28
15	CB15	0.47	4.80	10.00	2.76
25	CB25	0.63	4.96	11.02	3.41

## SADDLES



SD SERIES



SDT10



HTD10

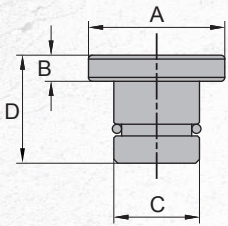

FIGURE #1

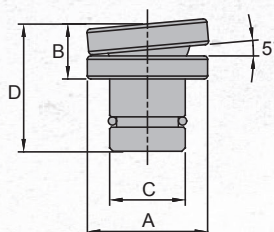

FIGURE #2

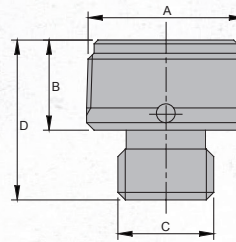

FIGURE #3

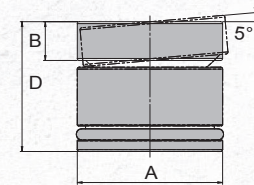

FIGURE #4

Saddle Type	Model Number	Capacity (ton)	For Cylinder(s)	Dimensions (in)				Figure Number
				A	B	C	D	
Tilt	SDT05	5	H05	0.98	1.22	-	0.63	2
	SDT10	10	H10	1.38	1.50	-	0.74	2
	SDT15	15	H15	1.50	1.57	-	0.73	2
	SDT25	25	H25	1.97	1.6	-	1.29	2
	SDT55	55-100	H55, HD55, H75, HD75, H100, HLN55 and HLN100	2.80	1.29	0.67	0.51	2
	SDTG100	100	HG100/HDG100	2.95	2.64	1.71	0.79	4
	SDTG150	150	HG150/HDG150	3.70	2.71	1.77	0.77	4
	SDTG200	200	HG200/HDG200	4.45	3.25	1.95	1.10	4
Grooved	SDT200	200	HLN 150/HLN200	5.12	1.77	1.02	0.53	4
	SD05	5	H05	0.98	0.81	-	0.24	1
	SD10	10	H10	1.38	1.06	-	0.24	1
	SD15	15	H15	1.50	1.18	-	0.28	1
Threaded	SD25	25	H25	1.97	1.14	-	0.28	1
	HTD10	10	HT1006 & HT1010	1 1/4"-11.5NPTF	0.95	1"-8UNC	1.77	3